

# GRADE 1 END TERM 2 EXAM, 2018

## ENVIRONMENTAL/RELIGIOUS ACTIVITIES

### The weather is

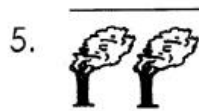
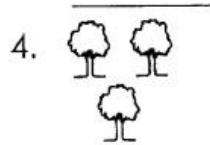
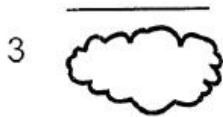
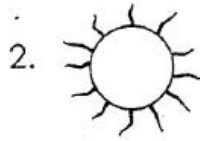

6. When going to school we wear school \_\_\_\_\_  
**(uniform, shorts, blouses)**

7. We sing the national \_\_\_\_\_ while raising the flag.  
**(choir, anthem)**

8. Who takes care of us at school?  
\_\_\_\_\_  
**(parents, teachers, ourselves)**

9. We sleep in the \_\_\_\_\_  
**(kitchen, sitting room, bedroom)**

10. The head of family is \_\_\_\_\_  
**(mother, father, son)**

11. \_\_\_\_\_ keeps our bodies warm. **(hat, clothes, water)**

12. A cow gives us \_\_\_\_\_  
**(milk, honey, water)**

13. Plates and cups are kept in the \_\_\_\_\_  
**(cupboard, table, box)**

14. After sweeping we put rubbish in the \_\_\_\_\_  
**(bucket, dustbin, pocket)**

15. Many trees growing together form a \_\_\_\_\_ **(farm, forest)**

### Name the pictures.

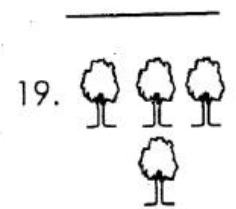
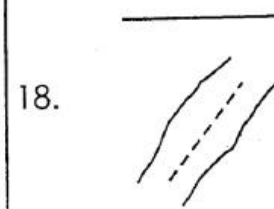
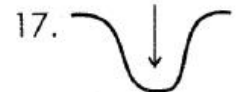

**(forest, road, valley, hills)**

### Name the parts of this house.

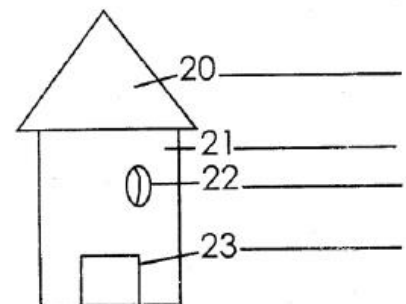

**(roof, door, window, walls)**

24. Rivers give us \_\_\_\_\_  
**(sand, water, soil)**
25. A plant needs \_\_\_\_\_, 26. and \_\_\_\_\_, 27. in order to grow.  
**(warmth, air, water, soil, house)**
28. We get eggs from \_\_\_\_\_



**(hen, cat)**

29. This is a \_\_\_\_\_

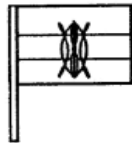

**(flag, post)**

30. Food is cooked in the \_\_\_\_\_  
**(kitchen, store)**

**C. R. E**

31. The wife of Abraham was called \_\_\_\_\_  
**(Mary, Sarah, Isaac)**
32. A deaf person cannot \_\_\_\_\_  
**(see, hear, smell)**
33. Moses was given the \_\_\_\_\_  
**(Bible, commandments, story book)**
34. \_\_\_\_\_ was killed by Cain.  
**(Abel, Eve, Adam)**
35. Jacob had \_\_\_\_\_ sons.  
**(11, 12, 14)**
36. Jesus had \_\_\_\_\_ disciples.  
**(11, 12, 10)**

37. Abraham was the father of \_\_\_\_\_  
**(John, Isaac, Matthew)**
38. The mother of Jesus was \_\_\_\_\_, while the father was 39 \_\_\_\_\_  
**(Joseph, John, Mary)**
40. \_\_\_\_\_ helped the widows.  
**(Tabitha, Hannah, Paul)**

**Draw the following God's creation.**

41. 

Trees	Mountains

42. 

Trees	Mountains

43. 

River	Lake

44. 

River	Lake

45. This is a \_\_\_\_\_



**(cross, timber)**

46. Christians worship in a \_\_\_\_\_  
**(church, mosque)**
47. I should \_\_\_\_\_ my mother. **(obey, kill, hate)**
48. Sinners will go to \_\_\_\_\_  
**(hell, heaven)**
49. The first man to be created was \_\_\_\_\_  
**(Adam, Eve, Judas)**
50. Jesus was born in \_\_\_\_\_  
**(Bethlehem, Jerusalem)**