

Name: Index No.

Adm No: Class:

232/2
PHYSICS THEORY
PAPER 2
SEPTEMBER 2022
TIME: 2 HOURS



ALLIANCE HIGH SCHOOL
Kenya Certificate of Secondary Education (K.C.S.E.)
TRIAL EXAMINATION

232/2
Physics
Paper 2

INSTRUCTIONS TO THE CANDIDATES:

- Write your name, index No, Adm No and Class in the spaces provided above.
- Answer *all* the questions both in section A and B in the spaces provided below each question
- All workings *must* be clearly shown; marks may be awarded for correct steps even if the answers are wrong.
- Mathematical tables and silent electronic calculators may be used.

FOR EXAMINERS' USE ONLY

SECTION	QUESTION	MAXIMUM SCORE	CANDIDATE'S SCORE
Section A	1-13	25	
Section B	14	11	
	15	14	
	16	09	
	17	10	
	18	07	
	19	07	
	TOTAL	80	

This paper consists of 12 printed pages. Candidates should check to ascertain that all pages are printed as indicated and that no questions is missing

SECTION A (25MARKS)

ANSWER ALL QUESTIONS IN THIS SECTION IN THE SPACES PROVIDED

1. Figure 1 shows a candle placed in front of a plane mirror. Study the diagram and answer the question that follows

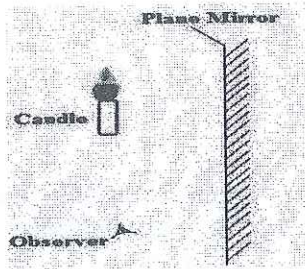

Using appropriate rays, locate the position of the image of the candle as seen by the observer (2 marks)

2. Figure 2 shows a positively charged gold-leaf electroscope. Study it and answer the questions that follow

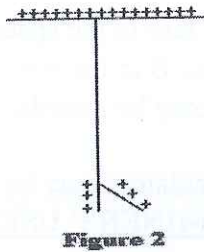

State and explain what happens to the leaf when a negatively charged rod is slowly brought close to the cap but not touching it (2 marks)

.....

.....

.....

3. One of the defects of simple primary cells is polarization. Explain how this defect prevents current flow in the cell (2 marks)

.....

.....

4. The figure shows a current carrying conductor placed in a magnetic field. Study it and answer the questions that follow

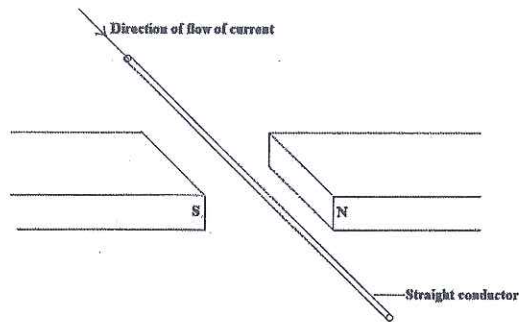

Indicate on the diagram the direction of the force acting on the current carrying conductor (1 mark)

5. The figure shows part of an electric circuit. It is observed that the ammeter reading is 2A when the circuit is connected as shown below.

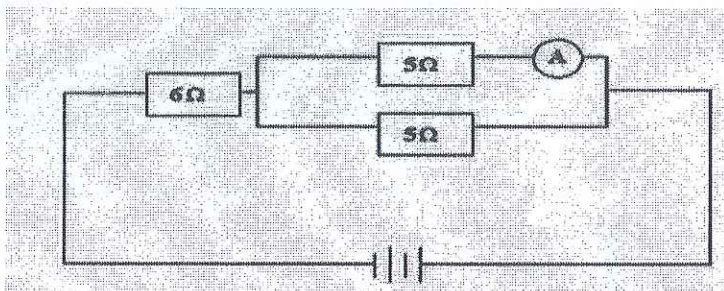

State the value of the current through the 6Ω resistor. (1mark)

6. The figure shows two wave fronts representing the same wave. Study the diagram and answer the questions that follow

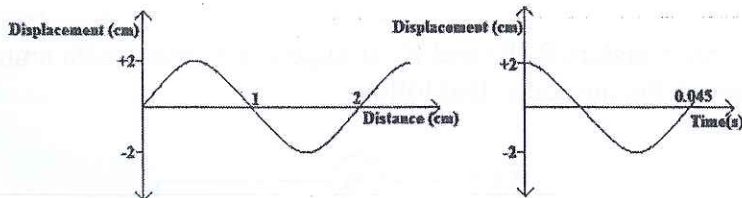

Determine the velocity of the wave (3 marks)

7. The figure shows a three-pin plug with parts labeled A, B and C. Study the diagram and answer the questions that follow

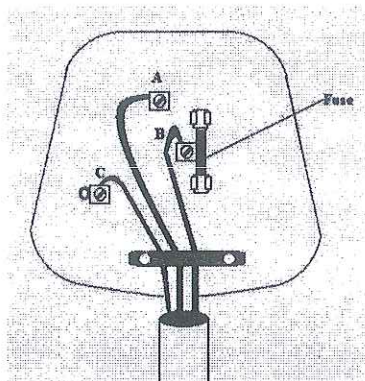

a) Name the plugs marked B (1 mark)

.....

b) Give two reasons why the plug marked A is longer (2 marks)

.....

8. One advantage of using convex mirror as vehicle side mirror is that it has a wider field of view than concave mirror. State the other one advantage it has over concave mirror (1 mark)

.....

9. Intrinsic semi-conductor can be converted to an extrinsic semi-conductor. Name the process (1 mark)

.....

10. The figure below shows three resistors R_1 , R_2 and R_3 arranged in a circuit with ammeters A_1 , A_2 and A_3 . Study the diagram and answer the questions that follow

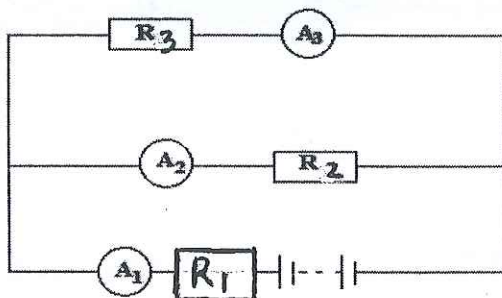

When the resistor R_1 is steadily heated, the reading of the ammeter A_2 decreases while that of A_3 increases. Explain this observation (2mks)

.....

11. The figure below shows a bar magnet placed close to a coil connected to a center zero galvanometer. Study the diagram and answer the questions that follow

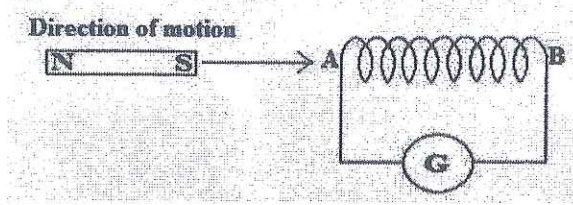

State and explain what is observed on the pointer of the galvanometer when the bar magnet is plunged into the coil. (2marks).....

12. The figure shows a standing wave formed when a string of length 3.0m stretched between two supports is plucked. Study the diagram and answer the questions that follow

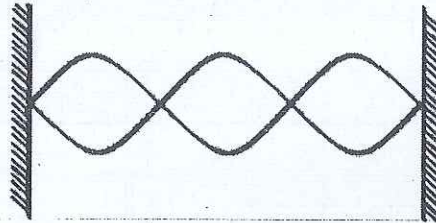

- a) State how the standing wave is formed (1 mark)

- b) Determine the wavelength of the standing wave (3 marks)

13. The figure shows a nail on which a wire is to be wound to make an electromagnet

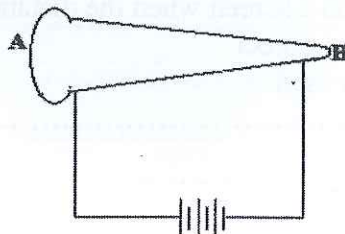

By drawing show on the diagram how the wire should be wound around the nail so that the end A becomes a north pole and end B south pole (1 mark)

SECTION B (55MARKS)

ANSWER ALL QUESTIONS IN THIS SECTION IN THE SPACES PROVIDED

14.

a) The graph shows the variation of magnification and image distance v for an object placed in front of a converging lens. Study the graph and answer the questions that follow

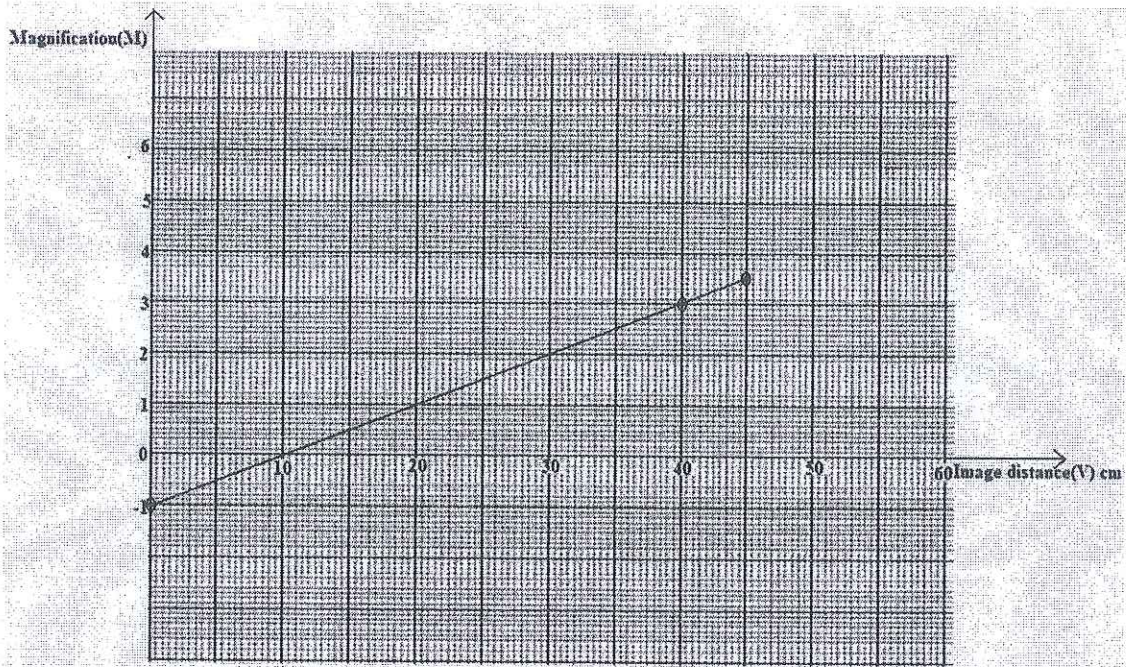

Using the equation $m = \frac{v}{f} - 1$ and the graph, determine

- i. The focal length f of the lens (3 marks)

- ii. The position of the object when the magnification is 2 (2 marks)

- iii. The power of the lens (2 marks)

b) A certain lens forms a focused image on a screen when the distance between the object and the screen is 81cm. the image size is twice that of the object

- i. State with a reason the type of lens used (2 marks)

- ii. Determine the object distance (2 marks)

15.

- a) The figure shows the displacement of a particle in a progressive wave incident on a boundary between deep and shallow regions.

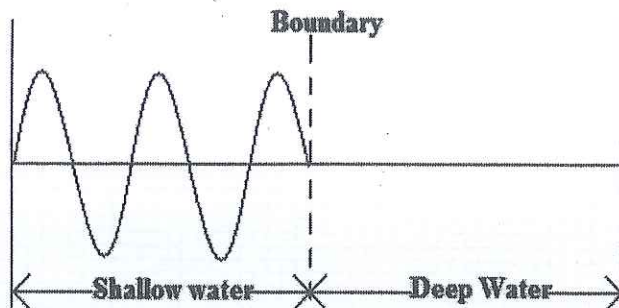

- i. Complete the diagram to show what is observed after boundary. (Assume no loss of energy) (1 mark)

- ii. Explain the observation in (i) above. (2 marks)

.....

.....

.....

- b) The figure shows two loud speakers S_1 and S_2 connected to same signal generator. Study the diagram and answer the questions that follow

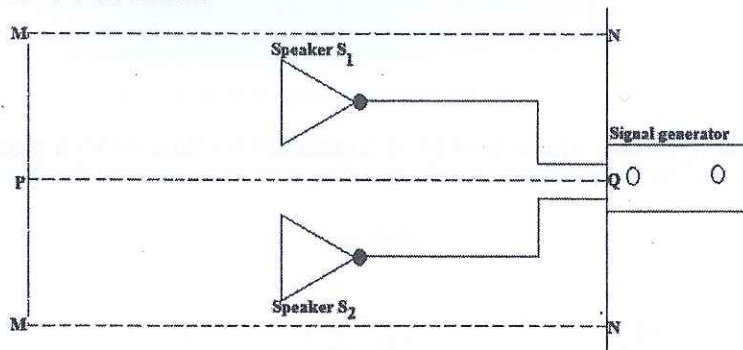

An observer walks along line PQ and another along the line MM for some distance.

- i. State the nature of sound along each of the paths (2 marks)

.....

.....

.....

- ii. Explain the observation along each of the two paths (2 marks)

.....

.....

.....

- c) The output of an a.c generator was connected to the input of the cathode ray oscilloscope whose time base setting was 5 milliseconds per centimeter and the y-gain at 10 volts per centimeter, *figure 10* below shows the waveform displayed on the screen of the C.R.O.

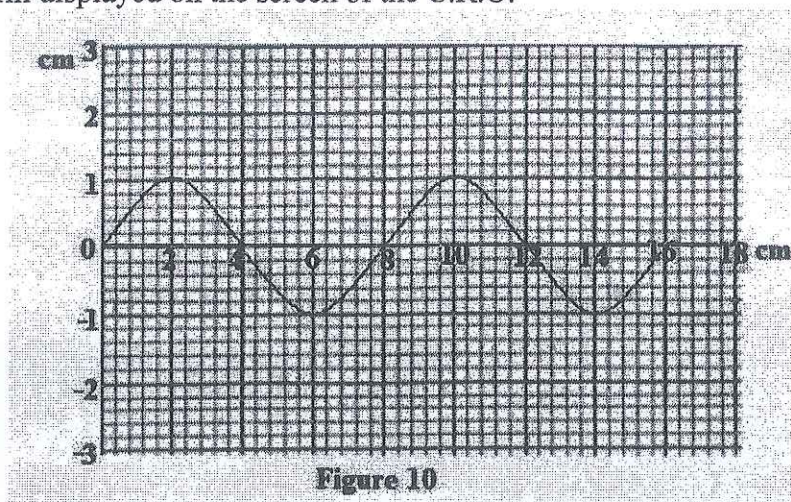

Determine

- i. The peak voltage of the generator. (1mark)
- ii. The frequency of the voltage. (3marks)

16.
a) The figure shows a bicycle dynamo. The wheel M is connected by an axle to a permanent cylindrical magnet and is rotated by the bicycle wheel. Study the diagram and answer the questions that follow

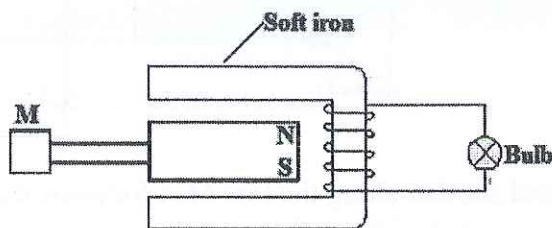

State two ways through which the brightness of the bulb can be increased in the dynamo (2 marks)

.....

- b) The figure shows an induction coil. Study the diagram and answer the questions that follow

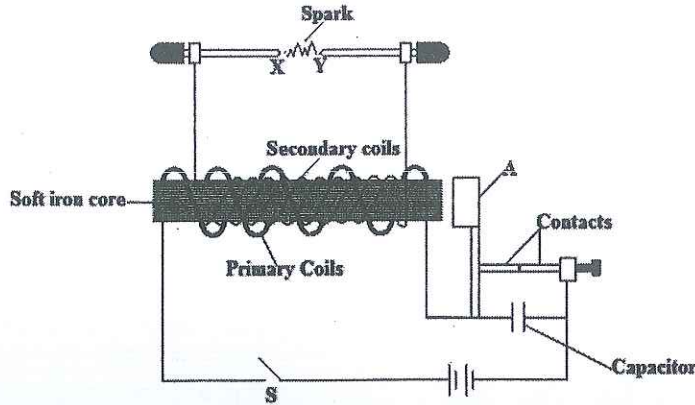

- i. Give the advantage of winding both the primary and secondary coil on the same soft iron core (1 mark)
- ii. Name the part marked A (1 mark)

.....

- iii. State the purpose of the capacitor in the circuit (1 mark)

.....

- iv. When the switch S is closed, a spark is produced between the parts marked X and Y. Explain how the spark is produced (3 marks)

.....

- v. State one difference between induction coil and a step-up transformer (1 mark)

.....

17.

- a) Distinguish between fission and fusion. (1 mark)

.....

- b) The figure below shows a decay of a certain element. The diagram is drawn to scale.

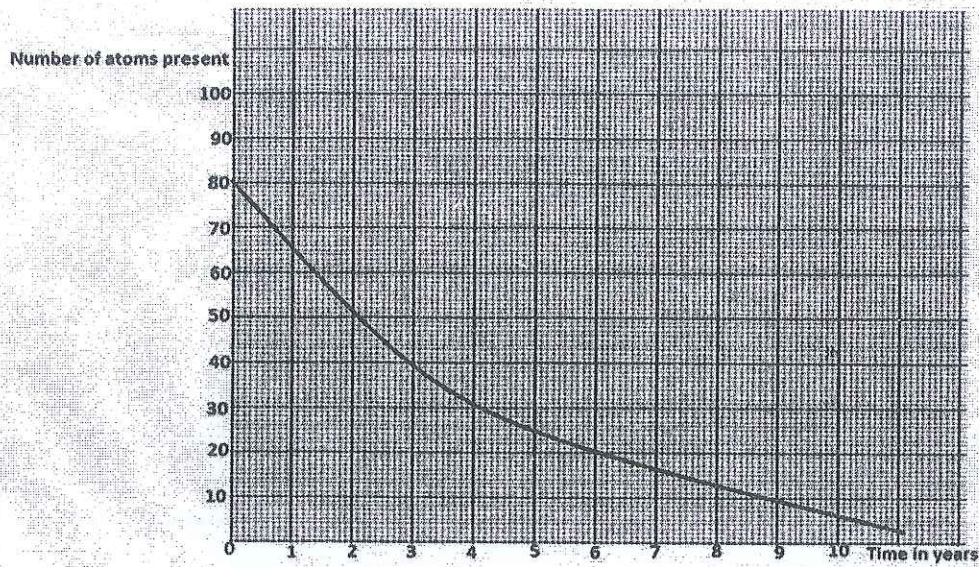

From the graph determine:

i. Half-life of the element. (1mark)

ii. Number of half-lives undergone when the count rate is 10 atoms. (1mark)

c) The following is part of a radioactive decay series.

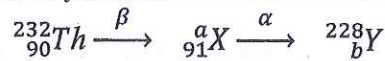

Determine the value of 'a' and 'b'.

(2marks)

d) The figure shows the essential component of an X-ray tube. Study it and answer the questions that follow

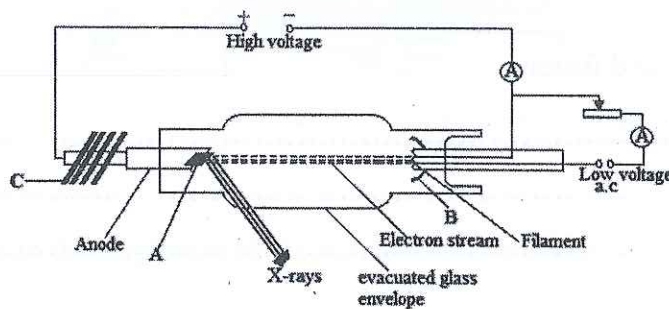

i. Name the element used in making the parts labeled A (1 mark)

ii. State the use of the part labeled C. (1mark)

iii. Explain how the X-rays are produced. (2marks)

.....
.....
.....
.....

iv. Give the reason why X-ray tube evacuated (1mark)

.....
.....

18.

a) State one way of increasing the capacitance of a parallel plate capacitor (1 mark)

.....

b) The figure shows a capacitor network connected to a source of voltage. Study the diagram and answer the questions that follow:

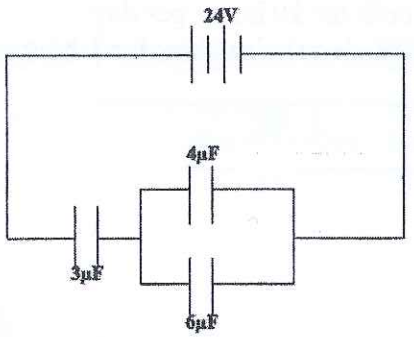

i. Determine the effective capacitance of the capacitor network (3 marks)

ii. Determine the charge through the 3µF capacitor (3 marks)

19.

a) The diagram on figure shows part of the National Grid system.

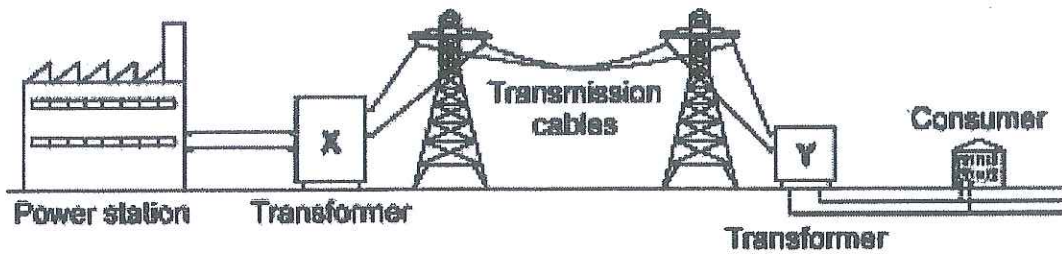

i. State with a reason the type of transformer that is placed at the location marked X (2 marks)

.....

.....

.....

ii. State two advantages of using circuit breakers in the consumer unit than using fuse wire. (2marks)

.....

.....

.....

b)

i. Calculate the cost of using the following appliances in one month (30 days) if the company rate is Ksh.9.50 per unit.

- I A 2000W water heater for 2 hours per day.
 - II A 75W bulb for 10 hours per day.
 - III An 1500W electric iron box for 1 hour per day
- (3 marks)

THIS IS THE LAST PRINTED PAGE